

# YUKEN

# ASR Series

## AC Servo Motor Driven Pumps



По вопросам продаж и поддержки обращайтесь:

Алматы (7273)495-231  
Ангарск (3955)60-70-56  
Архангельск (8182)63-90-72  
Астрахань (8512)99-46-04  
Барнаул (3852)73-04-60  
Белгород (4722)40-23-64  
Благовещенск (4162)22-76-07  
Брянск (4832)59-03-52  
Владивосток (423)249-28-31  
Владикавказ (8672)28-90-48  
Владимир (4922)49-43-18  
Волгоград (844)278-03-48  
Вологда (8172)26-41-59  
Воронеж (473)204-51-73  
Екатеринбург (343)384-55-89

Иваново (4932)77-34-06  
Ижевск (3412)26-03-58  
Иркутск (395)279-98-46  
Казань (843)206-01-48  
Калининград (4012)72-03-81  
Калуга (4842)92-23-67  
Кемерово (3842)65-04-62  
Киров (8332)68-02-04  
Коломна (4966)23-41-49  
Кострома (4942)77-07-48  
Краснодар (861)203-40-90  
Красноярск (391)204-63-61  
Курган (3522)50-90-47  
Курск (4712)77-13-04  
Липецк (4742)52-20-81

Магнитогорск (3519)55-03-13  
Москва (495)268-04-70  
Мурманск (8152)59-64-93  
Набережные Челны (8552)20-53-41  
Нижний Новгород (831)429-08-12  
Новокузнецк (3843)20-46-81  
Новосибирск (383)227-86-73  
Ноябрьск (3496)41-32-12  
Омск (3812)21-46-40  
Орел (4862)44-53-42  
Оренбург (3532)37-68-04  
Пенза (8412)22-31-16  
Пермь (342)205-81-47  
Петрозаводск (8142)55-98-37  
Псков (8112)59-10-37

Ростов-на-Дону (863)308-18-15  
Рязань (4912)46-61-64  
Самара (846)206-03-16  
Санкт-Петербург (812)309-46-40  
Саранск (8342)22-96-24  
Саратов (845)249-38-78  
Севастополь (8692)22-31-93  
Симферополь (3652)67-13-56  
Смоленск (4812)29-41-54  
Сочи (862)225-72-31  
Ставрополь (8652)20-65-13  
Сургут (3462)77-98-35  
Сыктывкар (8212)25-95-17  
Тамбов (4752)50-40-97  
Тверь (4822)63-31-35

Тольятти (8482)63-91-07  
Томск (8822)98-41-53  
Тула (4872)33-79-87  
Тюмень (3452)66-21-18  
Улан-Удэ (3012)59-97-51  
Ульяновск (8422)24-23-59  
Уфа (847)229-48-12  
Хабаровск (4212)92-98-04  
Чебоксары (8352)28-53-07  
Челябинск (351)202-03-61  
Череповец (8202)49-02-64  
Чита (3022)38-34-83  
Якутск (4112)23-90-97  
Ярославль (4852)69-52-93

Россия +7(495)268-04-70

Казахстан +7(7172)727-132

Киргизия +996(312)96-26-47

[yne@nt-rt.ru](mailto:yne@nt-rt.ru) || <https://yuken.nt-rt.ru>

## Hydraulic Fluids

### Hydraulic Fluids

Use clean petroleum base oils equivalent to ISO VG32 or 46. The recommended viscosity range is from 20 to 400 mm<sup>2</sup>/s and temperature range is from 0 to 60 °C , both of which have to be satisfied for the use of the above hydraulic oils.

### Control of Contamination

Due caution must be paid to maintaining control over contamination of the operating oil which can otherwise lead to breakdowns and shorten the life of the unit. Please maintain the degree of contamination within NAS class 9.

The suction port must be equipped with at least 100 μm (150 mesh) reservoir type filter and the return line must have a line type filter of under 10 μm.

## Instructions

### Transportation

For transportation, use the lifting rings on the pump. Do not use lifting cables at places other than the lifting rings.

### Mounting

When installing the pump, the filling port should be positioned upwards.

### Suction Pressure

Permissible suction pressure at the inlet port of the pump is between -16.7 and +50 kPa. For piping to the suction port, use pipes of the nominal diameters shown below. Make sure that the height of the pump suction port is lower than the oil level in the reservoir.

Model	Nominal Dia.
ASR 1 / ASR 2	3/4
ASR 3 / ASR 5	1 1/4
ASR10	2

### Hints on Piping

When using steel pipes for the suction or discharge ports, excessive load from the piping to the pump generates excessive noise. Whenever there is fear of excessive load, please use rubber hoses.

### Drain Piping

Install drain piping according to the chart and ensure that pressure within the pump housing should be maintained at a nominal pressure of less than 0.1 MPa and surge pressure of less than 0.5 MPa.

The length of piping should be less than 1 m. Instead of joining the drain pipe to other return lines, run it independently. The pipe end should be submerged in oil.

#### [Recommended Drain Piping Size]

Model	Fitting Size	Inside Dia. of Pipe
ASR 1 / ASR 2	3/8 (Inside Dia. 8.5 mm or more)	10 mm or more
ASR 3	1/2 (Inside Dia. 12 mm or more)	12 mm or more
ASR 5 / ASR10	3/4 (Inside Dia. 16 mm or more)	19 mm or more

**Starting**

Before first starting, fill the pump case with clean operating oil via the filling port. In order to avoid air blockage when first starting, adjust the control valves so that the discharged oil from the pump is returned directly to the reservoir or the actuator moves in a free load.

**Bleeding Air**

It may be necessary to bleed air from the pump case and lines to remove causes of vibration. An air bleed valve (Model Number: ST1004\*-10\*, Page21) in the outlet line is recommended.

For air bleeding with an air bleed valve installed, run the pump at a rotational speed that provides a flow rate equal to/higher than the valve's flow rate to reseating.

**Setting Safety Valve (Pressure) and Delivery**

At the time of shipment, the unit has been preset to the delivery rate shown below; the safety valve has been set to 21 MPa (19.5 MPa for ASR2). Adjust the preset delivery and safety valve (pressure) to meet your system requirements.

**[Default Setting of Delivery]**

Model Numbers	Single Displacement Type "X" cm <sup>3</sup> /rev	Dual Displacement Type "W" cm <sup>3</sup> /rev	
		Large Displacement	Small Displacement
ASR 1	15.8	15.8	8
ASR 2	22.2	22.2	8
ASR 3	36.9	36.9	10
ASR 5	56.2	56.2	14
ASR10	100	100	20

**[Volume of Pre-fill Oil Required]**

Model	Volume cm <sup>3</sup>
ASR 1/ASR 2	600
ASR 3/ASR 5	1200
ASR 10	2500

**Adjustment of Delivery**

Turning the flow adjustment screw for the single displacement type or the large displacement side flow adjustment screw for the dual displacement type clockwise decreases delivery. Turning the small displacement side flow adjustment screw for the dual displacement type clockwise increases delivery.

**[Volume adjusted by each full turn of the flow adjustment screw]**

Model Numbers	Single Displacement Type "X" cm <sup>3</sup> /rev	Dual Displacement Type "W" cm <sup>3</sup> /rev	
		Large Displacement	Small Displacement
ASR 1	1.4	1.4	1.5
ASR 2	2.0	2.0	2.1
ASR 3	2.9	2.9	2.8
ASR 5	3.9	3.9	3.7
ASR10	5.4	5.4	7.9

★ For the relationship between the flow adjustment screw position and flow adjustment, see pages 6 and 7.

**Adjustment of Safety Valve (Pressure)**

• **Single Displacement Type**

Turning the pressure adjustment screw clockwise increases pressure.

See the chart for the pressure change per turn of the adjustment screw. After adjustment, be sure to tighten the lock nut.

Model Numbers	Pressure Change Per Turn MPa	Max. Setting Value MPa	Min. Setting Value MPa
ASR1/ASR3/ASR5-※※-HX	4.4	24.8	8
ASR10-※※-HX			2
ASR2-※C-CX		19.5	2

★ For the relationship between the pressure adjustment screw position and pressure adjustment, see page 6.

• **Dual Displacement Type**

The dual displacement type does not support the full cut-off function. Provide a safety valve on the pump discharge side.

Set the safety valve at a value of the maximum operating pressure + 3 to 3.5 MPa.

**Precautions During Operation**

During and for a period after operation, the surface temperature of the AC servo motor and the pump will be hot. Prevent hands and other body parts from coming into contact with them.

**Interchangeability in Installation between Current and New Designs**

The models shown below have been changed in design.

Name	Model Numbers	Design Number		Interchangeability in Installation	Major Changes
		Current	New		
ASR Series AC Servo Motor Driven Pumps	ASR2-※C-C※※※※-※00 ASR10-※※-H※※※※-※00	11	12	Yes	● Improvement of reliability

# Providing flexible flow/pressure control !

## ASR Series AC Servo Motor Driven Pumps

The ASR series provides variable flow by driving a piston pump directly with an AC servo motor and controlling the rotational speed in a range from zero to the maximum level. This series allows precise control of flow/pressure by using a dedicated AMSR controller. It also offers excellent response and repeatability.

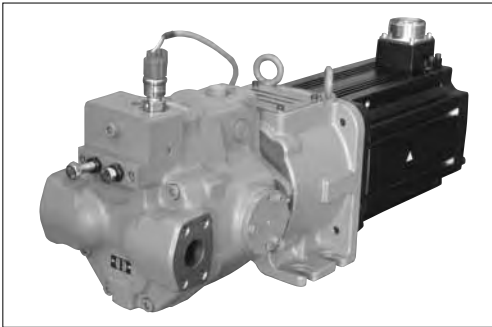

### System Configuration

A feedback loop is formed by the AMSR controller that computes deviations between control signals from the machine side (speed and pressure commands) and sensor signals to drive the AC servo motor accordingly. Control parameters can be set digitally by using dedicated software.

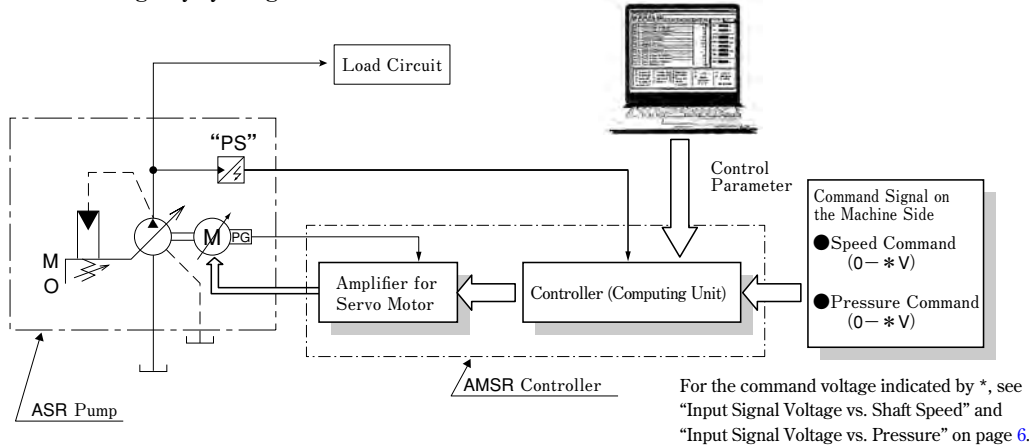

### Graphic Symbols

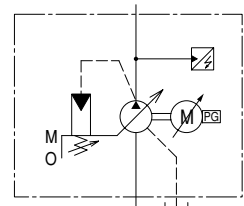

Single Displacement Type  
ASR \* - \* \* - \* X \* -

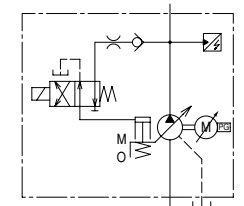

Dual Displacement Type  
ASR \* - \* \* - \* W \* -

### Energy saving with low heat generation

These pumps run at a rotational speed suitable for mechanical requirements, eliminating unnecessary power loss. They minimize heat generation in the fluid and allow the use of a significantly smaller reservoir.

### Example of Power Consumption by Pump Control Type

	ASR Series	04EH Type	Load Sensing Type
Reduction Rate	30~70	60~80	100

Reduction Rate 30-70%

### Low noise

The motor operates at near-zero speed during unloaded operation or pressure control, keeping the noise level extremely low.

### High performance

The AC servo motor, which directly controls the pump speed, improves response and stability at low pressures and speeds.

### Digital AMSR controller that saves space and wiring

The integration of the amplifier for the servo motor and the controller saves space and wiring. The parameters can be digitally adjusted in an easy and repeatable way.

### Dual displacement type for a wider operation range

The dual displacement type has a solenoid operated directional valve to switch between large and small swash plate angles. A single pump unit of the dual displacement type can operate both with low pressure/large flow and with high pressure/small flow. Thus, in comparison to the single displacement type with the same motor capacity, the dual displacement type covers a significantly wider range of operating pressures and flow rates.

### Large flow

The AMSR controller has a combination function that supports operation with large flow up to 3200 L/min (ASR10 x 16 units).

Specifications

Description		Model Numbers		ASR 1-	ASR 2-	ASR 3-	ASR 5-	ASR10-					
		Power Capacity		C	C	E	G	J	M				
Pump	Flow Control	Max. Flow	39.5 L/min		55.5 L/min		92.3 L/min		129 L/min		200 L/min		
		Min. Adj. Flow	1%										
		Hysteresis	1% or less										
		Repeatability	1% or less										
		Input Signal Voltage	31.6 L/min / 5V		44.4 L/min / 5V		73.8 L/min / 5V		112.4 L/min / 5V		200 L/min / 5V		
		Max. Permissible Input Signal Voltage*	39.5 L/min / 6.25V		55.5 L/min / 6.25V		92.3 L/min / 6.25V		129 L/min / 5.75V				
	Pres. Control	Max. Operating Pres.	21 MPa		16 MPa		21 MPa						
		Min. Adj. Pres.	0.1 MPa										
		Hysteresis	1% or less										
		Repeatability	1% or less										
		Input Signal Voltage	17.5 MPa / 5V		16 MPa / 4.57V		17.5 MPa / 5V						
		Max. Permissible Input Signal Voltage*	21 MPa / 6V				21 MPa / 6V						
AC Servo Motor Specifications	Rated Output		4.5 kW			6 kW	8 kW		11 kW		15 kW		
	Insulation Class		Class F										
	Cooling System		Totally-enclosed Self-cooling						Totally-enclosed Fan-cooling				
	Cooling Fan Power Consumption		—————						62W (50Hz) / 76W (60Hz)				
	Environmental Condition	Ambient Temperature		0 - +40 °C (No Freezing)									
Ambient Humidity		80 %RH or less (No Condensation)											
Mass	Single Displacement Type		54 kg		54 kg		80 kg	87 kg	94 kg	175.5 kg	213 kg	233 kg	
	Dual Displacement Type		55 kg		55 kg		82 kg	89 kg	96 kg	177.5 kg	214 kg	234 kg	
Applicable Controller Model Number		AMSR- * C - * 00-10				AMSR- 2DE- * 00-10		AMSR- * FGI- * 00-10		AMSR- * HJL- * 00-10		AMSR- * KMO- * 00-10	

★By adjusting the controller, the maximum flow rate/5 V (39.5 L/min/5 V) and the maximum operating pressure/5 V (21 MPa/5 V) can be set.

Model Number Designation

The model numbers below indicate packages each containing an AC servo motor driven pump, AMSR controller, and dynamic brakes.

ASR3	-4	G	-H	X	S	A100	N	-A	00	-11
Series Number	Power Supply Voltage	Power Capacity	Max. Operating Pres.	Flow Setting	Port Direction	Coil Type for Solenoid Operated Directional Valve	Electrical Conduit Connection for Solenoid Operated Directional Valve	Function Selection	Parameter Number	Design Number
ASR1	None : AC 200 V	C	H : 21 MPa	X : Single Displacement Type	S : Side	AC A100 : AC100V A120 : AC120V A200 : AC200V A240 : AC240V	None: Terminal Box	A: Single	00: Standard	11
ASR2		C	C : 16 MPa			DC None : DC24V D12 : DC12V D48 : DC48V D100 : DC100V D110 : DC110V D200 : DC200V D220 : DC220V				12
ASR3	4 : AC 400 V	E★ <sup>3</sup> , G	H : 21 MPa	W : Dual Displacement Type	None : Axial	AC (AC <-> DC) R100 : AC100V R110 : AC110V R200 : AC200V R220 : AC220V	N: DIN Plug-in Connector (Optional)	B: Combination★ <sup>6</sup> (Single Operation Allowed)		11
ASR5		G, J								11
ASR10		J, M								12

★1. To order an AC servo motor driven pump separately for spare use, prefix “N-” to the model number and omit the Function Selection and Parameter Number.

Example) N-ASR3-4G-HXSA100N-11

★2. For the relationship between the power capacity and the pressure/flow in terms of specification limits, see charts on pages 8 and 9.

★3. When selecting the power capacity “E”, only an input voltage of AC 200 V is available.

★4. Types shown in the shaded areas are optional. Check the delivery date before selecting them.

★5. This is applicable only when “W” is selected for flow setting.

★6. For combination operation, consult us separately regarding the types of hydraulic circuits, components, and electric cables.

## Solenoid Ratings

Electric Source	Coil Type	Frequency (Hz)	Voltage (V)		Current & Power at Rated Voltage		
			Source Rating	Serviceable Range	Inrush* (A)	Holding (A)	Power (W)
AC	A 100	50	100	80 – 110	2.42	0.51	—
		60	100	90 – 120	2.14	0.37	
			110		2.35	0.44	
	A 120	50	120	96 – 132	2.02	0.42	
		60		108 – 144	1.78	0.31	
	A 200	50	200	160 – 220	1.21	0.25	
				180 – 240	1.07	0.19	
		60	220		1.18	0.22	
	A 240	50	240	192 – 264	1.01	0.21	
		60		216 – 288	0.89	0.15	
DC (K Series)	D 12	—	12	10.8 – 13.2	—	2.45	29
	D 24		24	21.6 – 26.4		1.23	
	D 48		48	43.2 – 52.8		0.61	
AC (AC <=> DC)	R 100	50/60	100	90 – 110	—	0.33	29
	R 200		200	180 – 220		0.16	

★Inrush current in the above table shows rms values at maximum stroke.

## Pipe Flange Kit

No pipe flange kit is included with the pump. The pipe flange kits below are available if required. For the details of the pipe flange kits, see pages 20 and 21.

Pump Model Numbers	Name of Port	Pipe Flange Kit Numbers		
		Threaded Connection	Socket Welding*	Butt Welding
ASR 1 ASR 2	Suction	F5-06-A-10	F5-06-B-10	F5-06-C-10
	Discharge	F5-06-A-10	F5-06-B-10	F5-06-C-10
ASR 3 ASR 5	Suction	F5-10-A-10	F5-10-B-10	F5-10-C-10
	Discharge	F5-10-A-10	F5-10-B-10	F5-10-C-10
ASR 10	Suction	F5-16-A-10	F5-16-B-10	F5-16-C-10
	Discharge	F5-10-A-10	F5-10-B-10	F5-10-C-10

★For the socket welding type F5-06-B-10 or F5-10-B-10, the operating pressure may be limited due to the flange strength.

## Characteristics of Single Displacement Type

### Input Signal Voltage vs. Pressure

● ASR1/ASR3/ASR5/ASR10-\*\*-HX

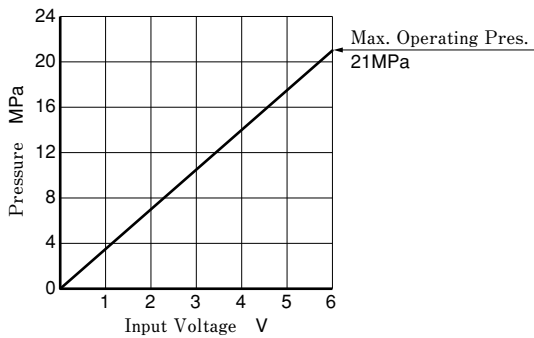

● ASR2-\*\*-CX

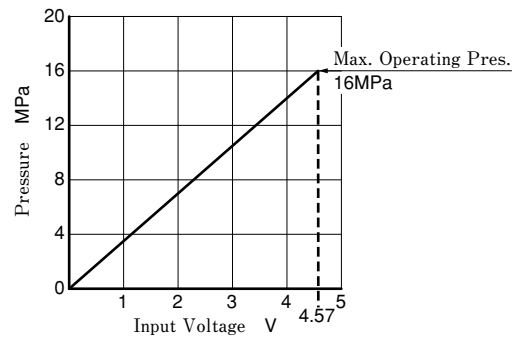

★ Do not input a voltage higher than the level corresponding to the maximum operating pressure.

### Input Signal Voltage vs. Shaft Speed

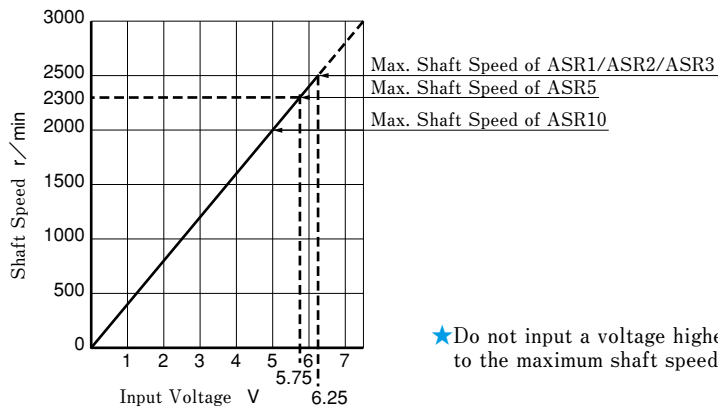

★ Do not input a voltage higher than the level corresponding to the maximum shaft speed.

### Safety Valve Pressure Adjustment Screw Projection and Safety Valve Setting Pressure

● ASR1/ASR3/ASR5-\*\*-HX

● ASR2-\*\*-CX

● ASR10-\*\*-HX

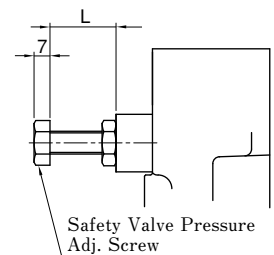
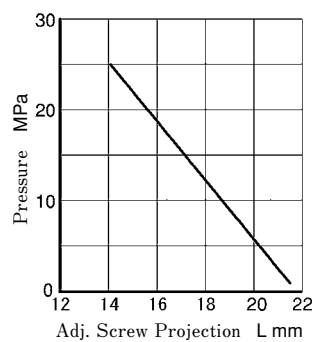
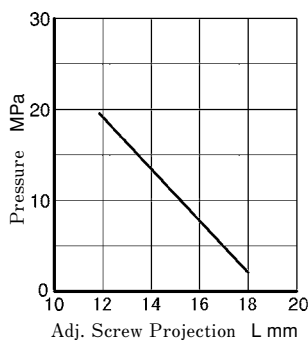
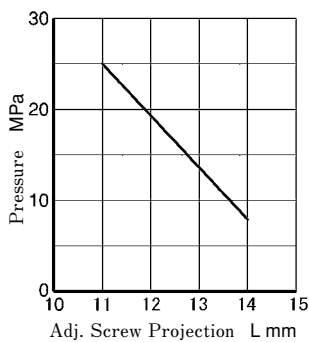

### Flow Adjustment Screw Projection and Geometric Displacement

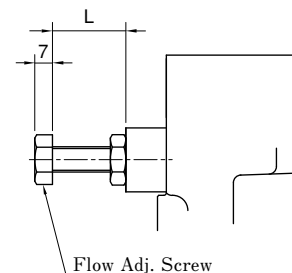
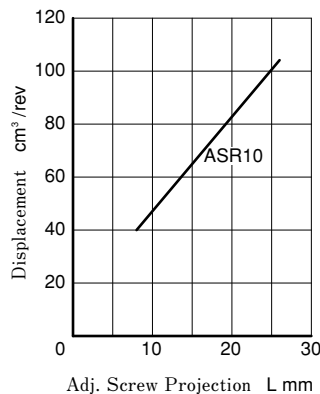
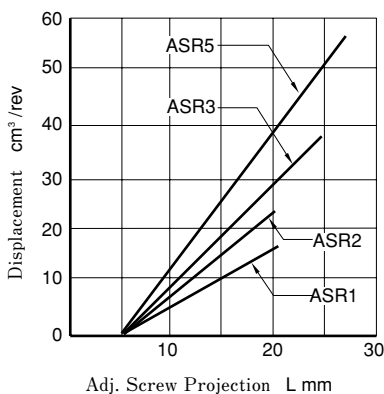

## Characteristics of Dual Displacement Type

**Input Signal Voltage vs. Pressure**

See “Characteristics of Single Displacement Type” (page 6).

**Input Signal Voltage vs. Shaft Speed**

See “Characteristics of Single Displacement Type” (page 6).

**Flow Adjustment Screw Projection and Geometric Displacement**

Large Displacement Side Flow Adj. Screw (Check operation with the solenoid operated directional valve “off”.)

This is the same as the single displacement type. See “Characteristics of Single Displacement Type” (page 6).

Note that the value cannot be set below the level set by the small displacement side adjustment screw.

Small Displacement Side Flow Adj. Screw (Check operation with the solenoid operated directional valve “on” and at a load pressure of 3 MPa or more.)

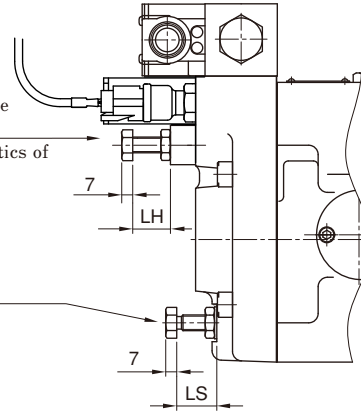

**[Small Displacement]**

● ASR1- \*C-HW

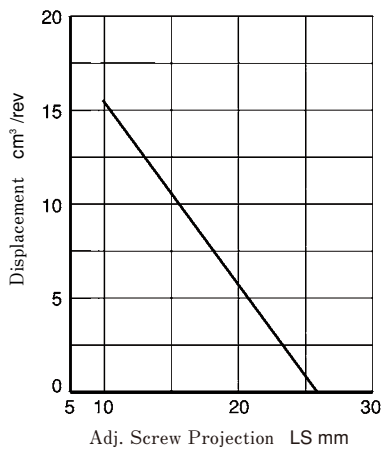

● ASR2- \*C-CW

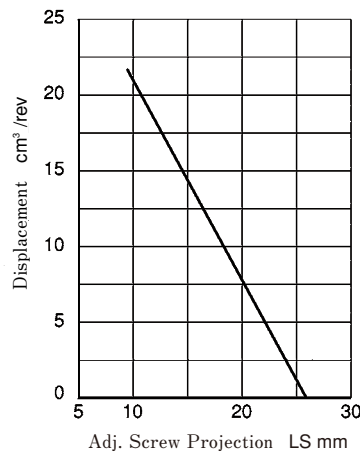

● ASR3- \* \*-HW

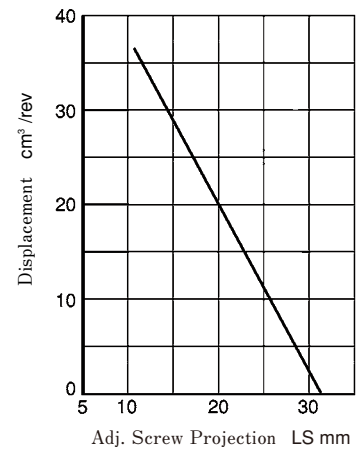

● ASR5- \* \*-HW

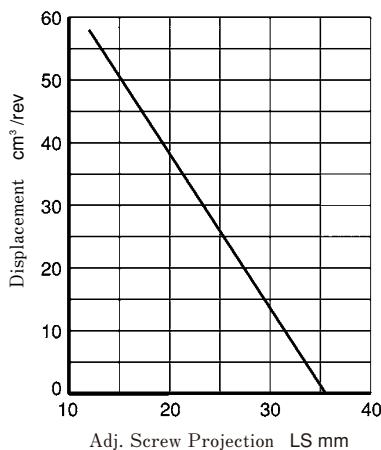

● ASR10- \* \*-HW

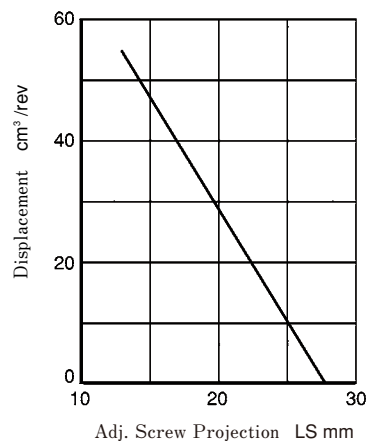



**Single Displacement Type "X" Model Selection Chart (Representative Pressure vs. Flow Characteristics)**

The area ① in each chart indicates that continuous operation is allowed by default.

The area ② indicates that continuous operation is allowed by adjusting the flow rate (see the figure below). For details, consult us separately.

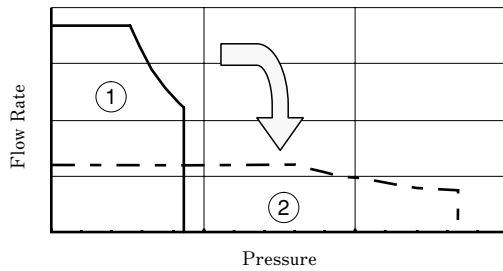

(Note) Since the ASR series employs variable displacement pumps, the pressure and flow rate ranges for continuous operation can be adjusted as shown on the left.

The area ③ in each chart indicates that intermittent operation is allowed. The allowable operation time varies depending on the cycle of operation. For details, consult us separately.

● ASR1- \*C-HX\* - \*00-11

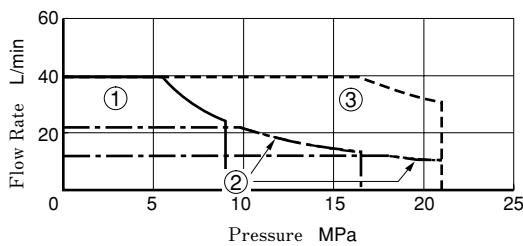

● ASR2- \*C-CX\* - \*00-12

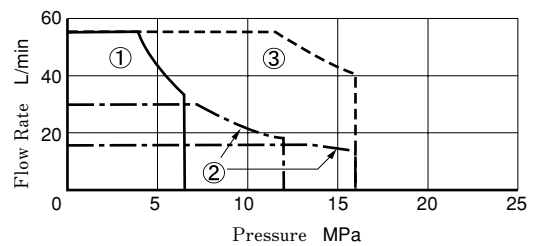

● ASR3-E-HX\* - \*00-11

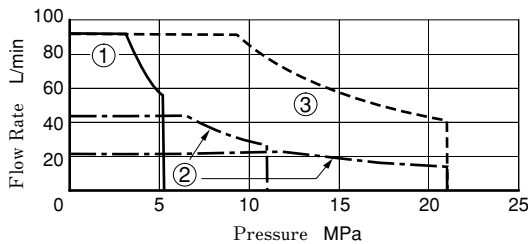

● ASR3- \*G-HX\* - \*00-11

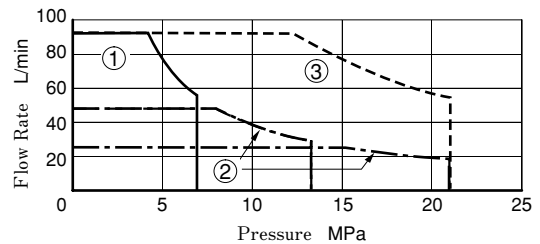

● ASR5- \*G-HX\* - \*00-11

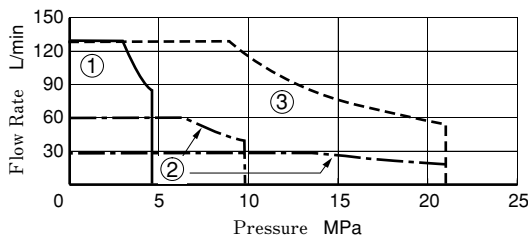

● ASR5- \*J-HX\* - \*00-11

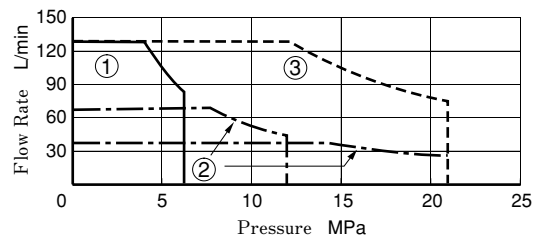

● ASR10- \*J-HX\* - \*00-12

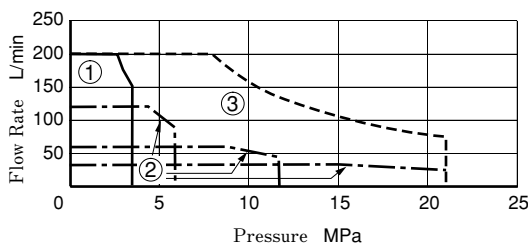

● ASR10- \*M-HX\* - \*00-12

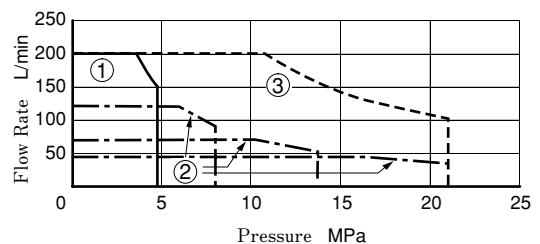

**Dual Displacement Type "W" Model Selection Chart (Representative Pressure vs. Flow Characteristics)**

The area ① in each chart indicates that continuous operation is allowed by default with the large displacement.

The area ② indicates that continuous operation is allowed by default with the small displacement.

Both areas ① and ② can be changed as shown below by adjusting the pump discharge capacity. For details, consult us separately.

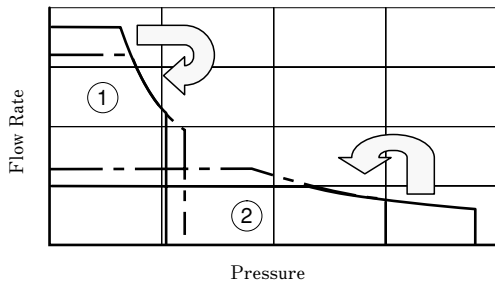

(Note) Since the ASR series employs variable displacement pumps, the pressure and flow rate ranges for continuous operation can be adjusted as shown on the left.

The area ③ in each chart indicates that intermittent operation is allowed. The allowable operation time varies depending on the cycle of operation. For details, consult us separately.

● ASR1- \*C-HW\* - \*00-11

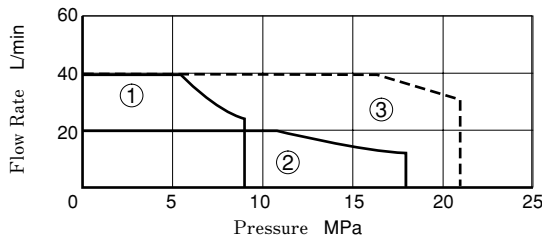

● ASR2- \*C-CW\* - \*00-12

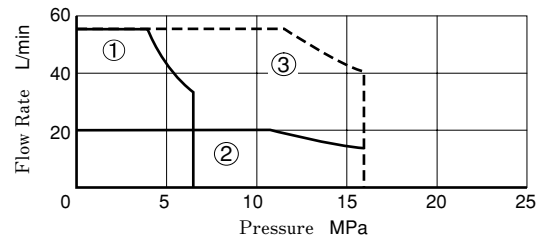

● ASR3-E-HW\* - \*00-11

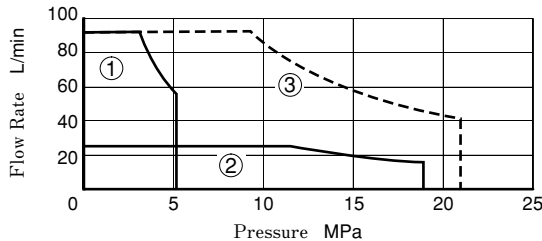

● ASR3- \*G-HW\* - \*00-11

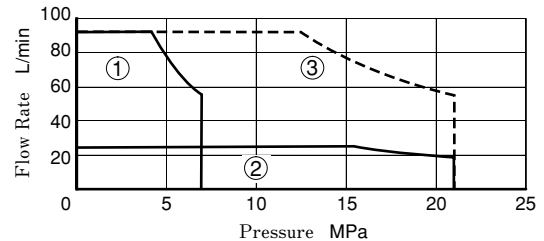

● ASR5- \*G-HW\* - \*00-11

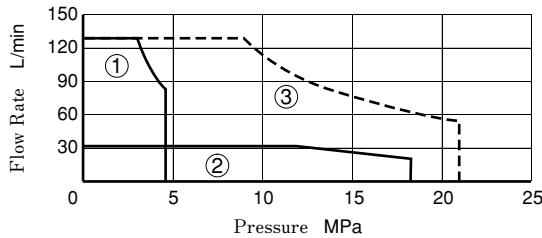

● ASR5- \*J-HW\* - \*00-11

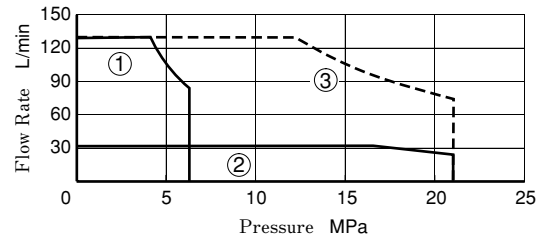

● ASR10- \*J-HW\* - \*00-12

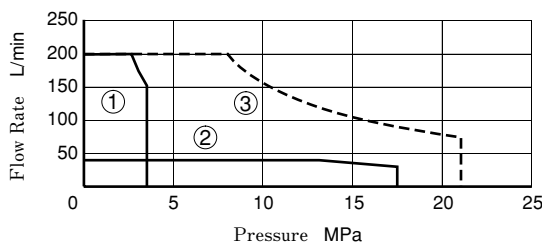

● ASR10- \*M-HW\* - \*00-12

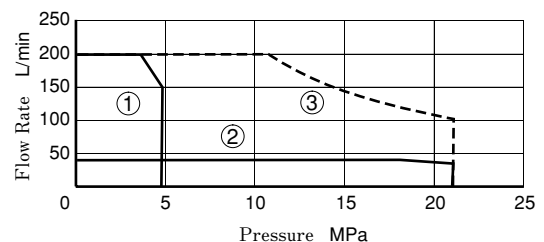

**ASR1- \* C-HXS- (Side Port Type)**  
**ASR2- \* C-CXS- (Side Port Type)**

**Single Displacement Type**

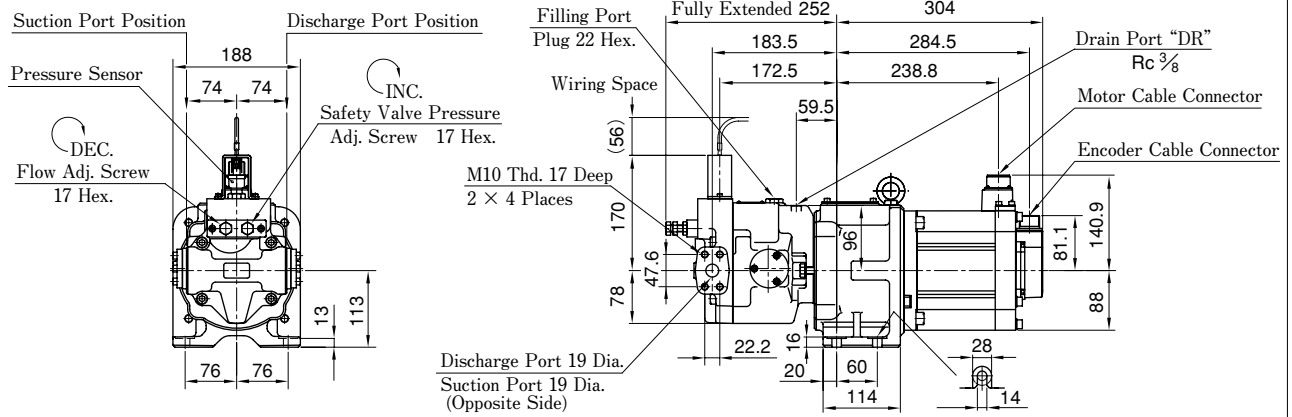

**ASR1- \* C-HX- (Axial Port Type)**  
**ASR2- \* C-CX- (Axial Port Type)**

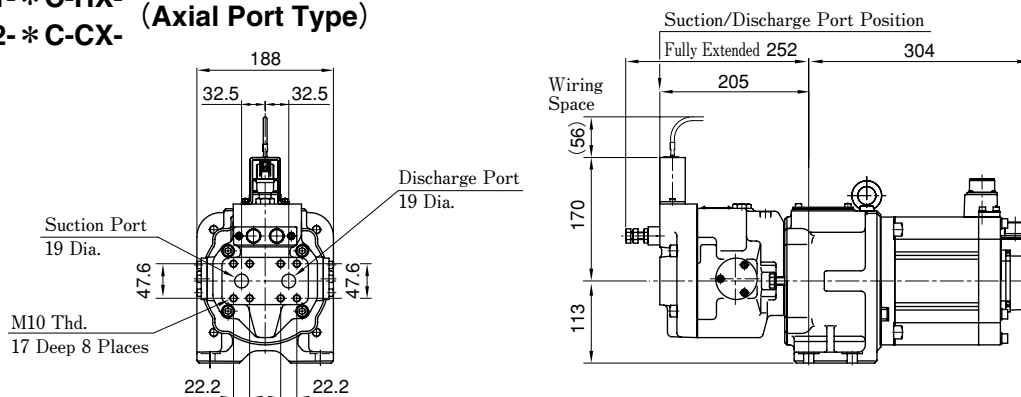

● For other dimensions, see the figure for the side port type.

**ASR1- \* C-HWS- (Side Port Type)**  
**ASR2- \* C-CWS- (Side Port Type)**

**Dual Displacement Type**

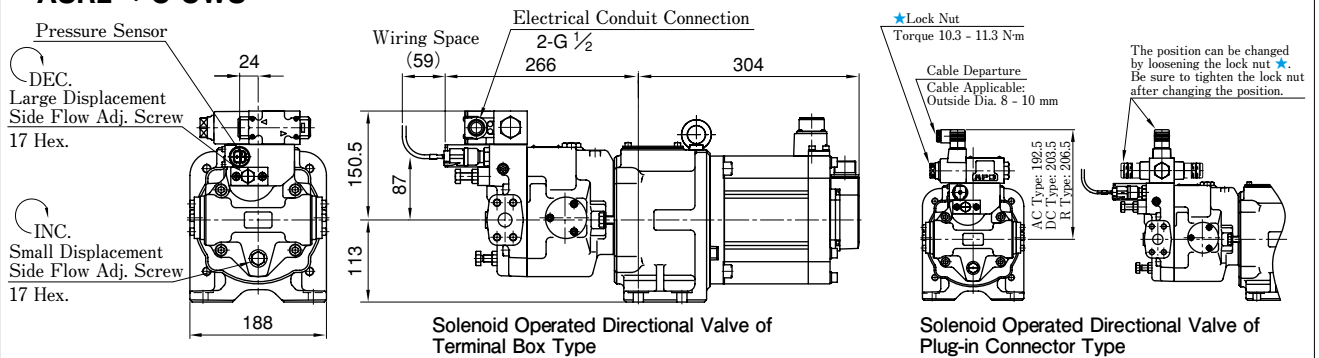

● For other dimensions, see the figure for the single displacement type.

**ASR1- \* C-HW- (Axial Port Type)**  
**ASR2- \* C-CW- (Axial Port Type)**

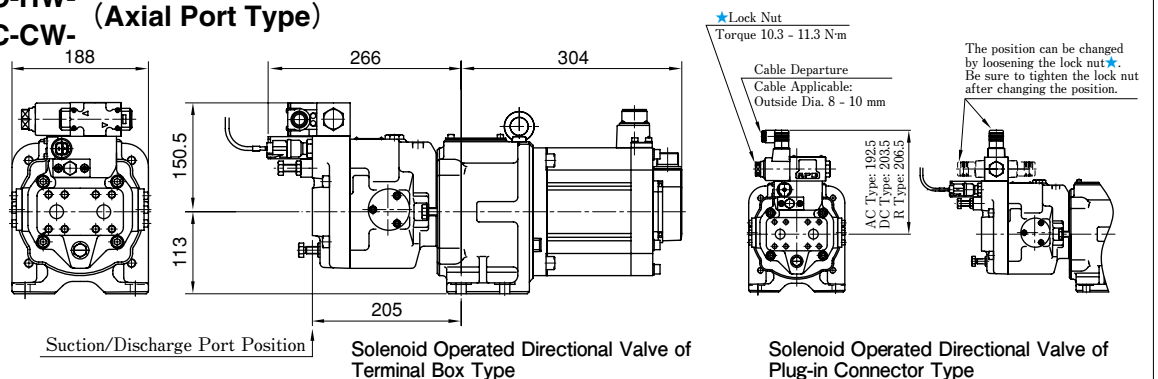

● For other dimensions, see the figure for the single displacement type.

**ASR3-\*\*-HXS- (Side Port Type)**

**Single Displacement Type**

Model Numbers	A	B	C	D
ASR3-E-H*S-	364	344.5	290.8	149.1
ASR3-G-H*S-	404	384.5	330.8	149.1

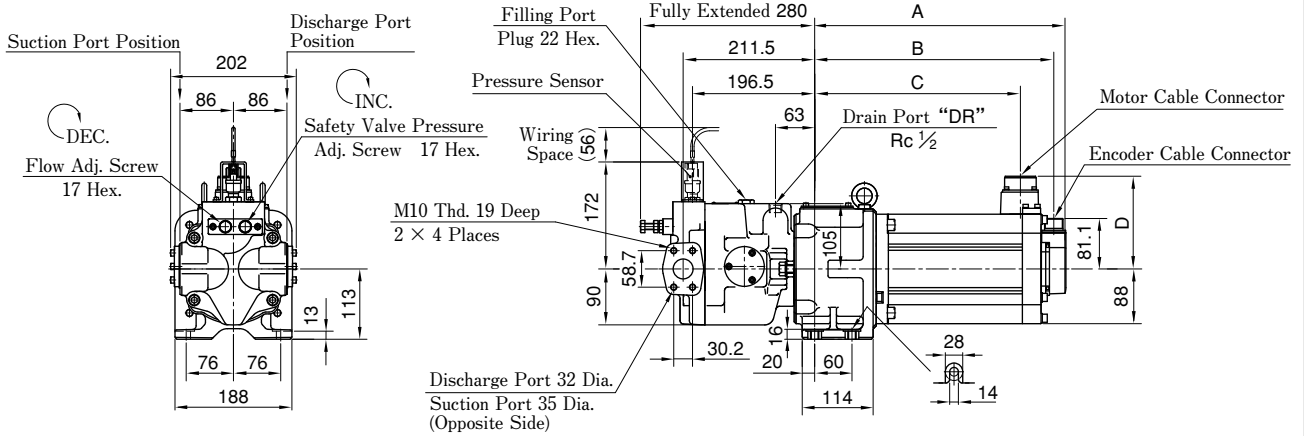

**ASR3-\*\*-HX- (Axial Port Type)**

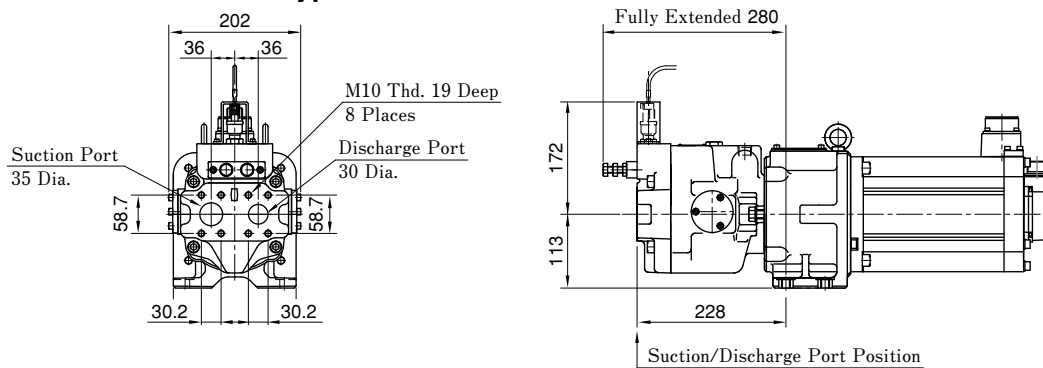

● For other dimensions, see the figure for the side port type.

**ASR3-\*\*-HWS- (Side Port Type)**

**Dual Displacement Type**

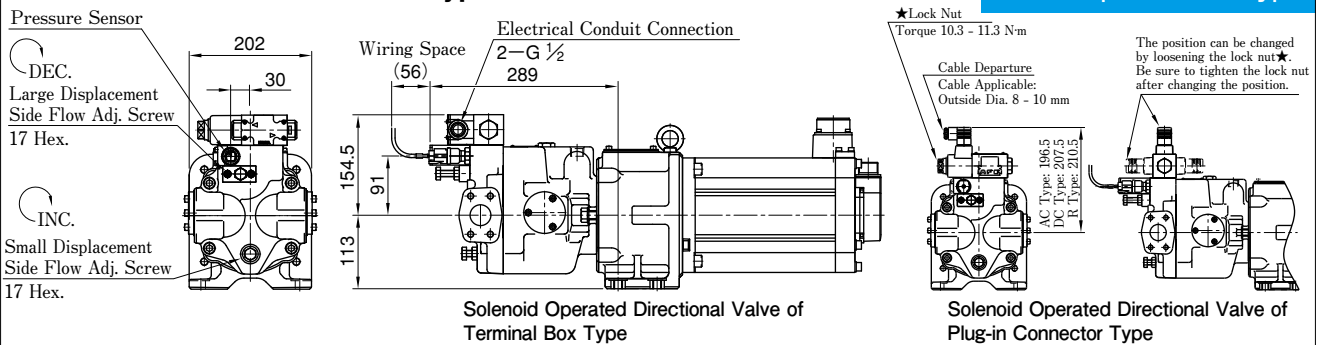

● For other dimensions, see the figure for the single displacement type.

**ASR3-\*\*-HW- (Axial Port Type)**

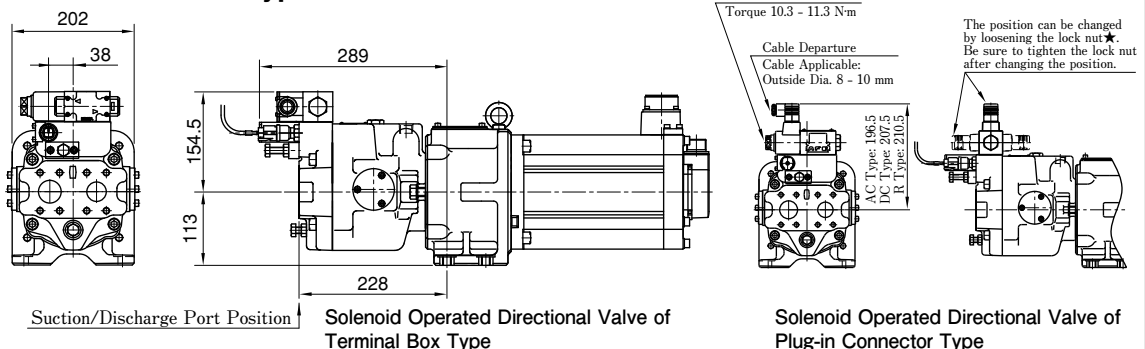

● For other dimensions, see the figures for the single displacement type and the dual displacement side port type.

**ASR5- \* G-HXS- (Side Port Type)**

**Single Displacement Type**

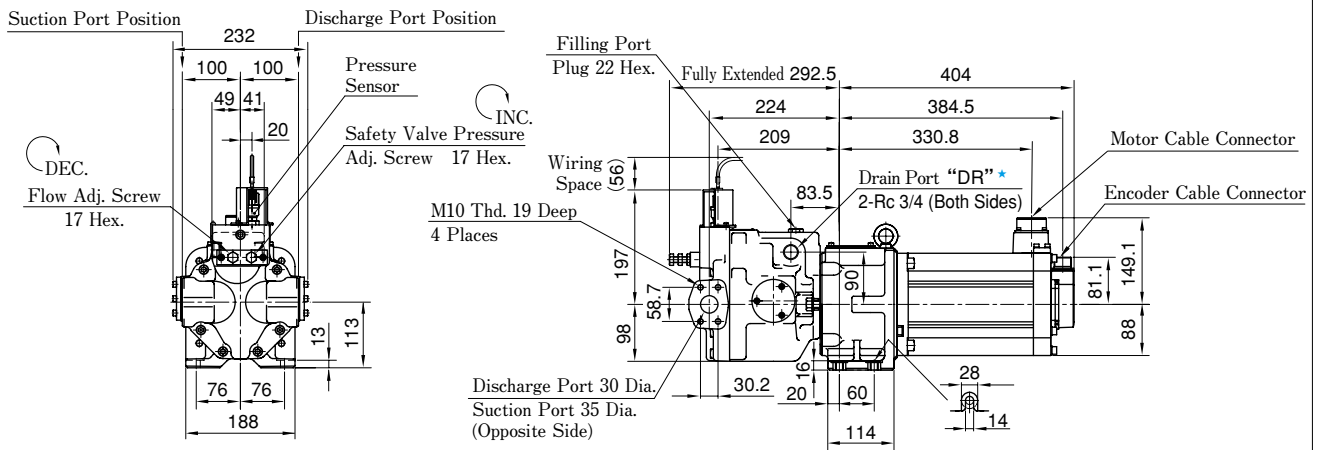

★Use either of two drain ports at your option. Keep the unused port plugged.

**ASR5- \* G-HX- (Axial Port Type)**

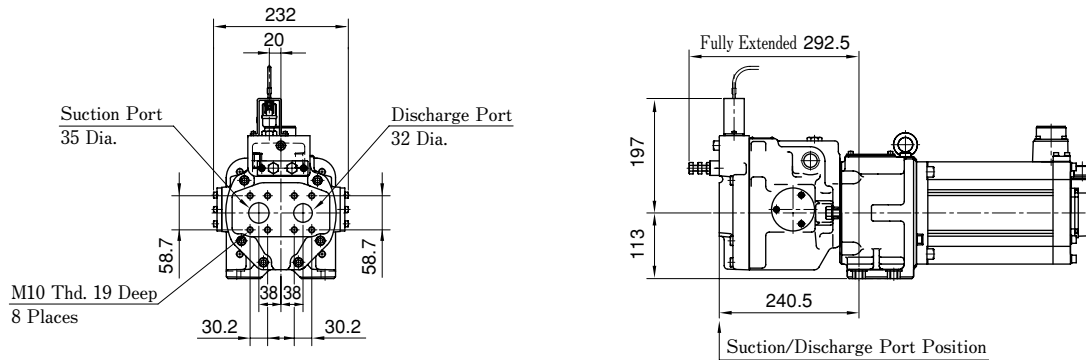

**ASR5- \* G-HWS- (Side Port Type)**

**Dual Displacement Type**

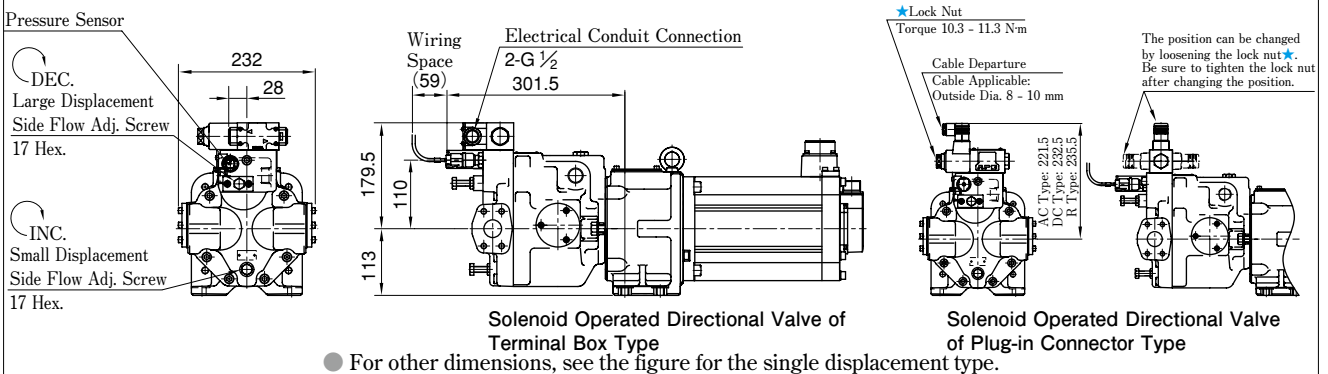

● For other dimensions, see the figure for the single displacement type.

**ASR5- \* G-HW- (Axial Port Type)**

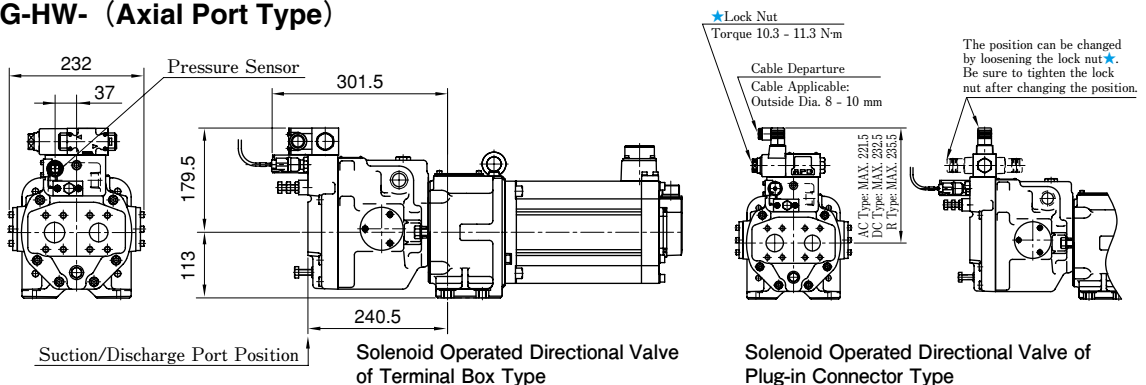

● For other dimensions, see the figures for the single displacement type and the dual displacement side port type.

**ASR5- \* J-HXS- (Side Port Type)**

**Single Displacement Type**

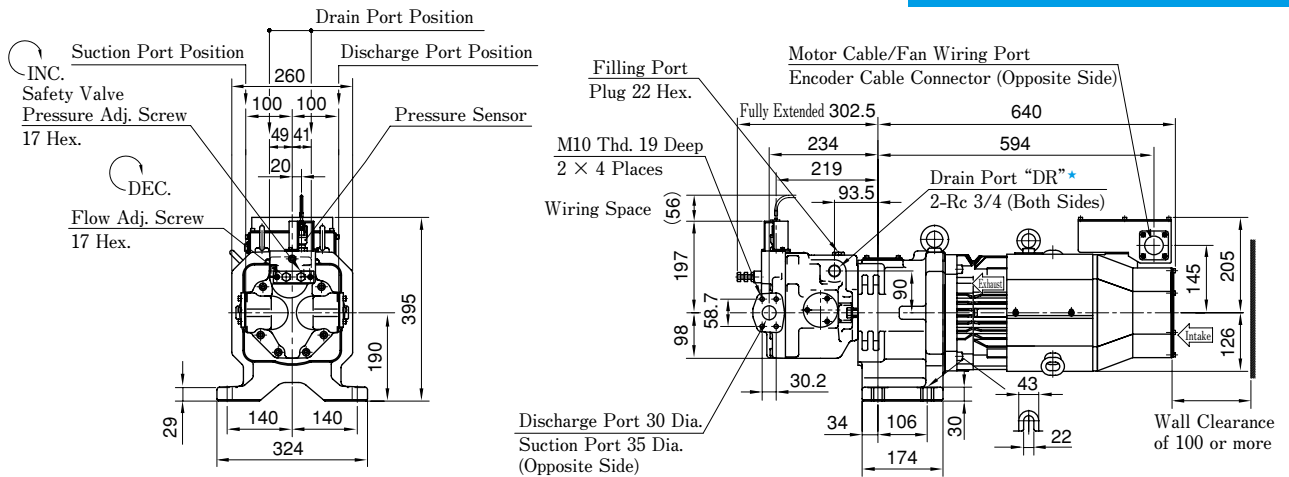

★ Use either of two drain ports at your option. Keep the unused port plugged.

**ASR5- \* J-HX- (Axial Port Type)**

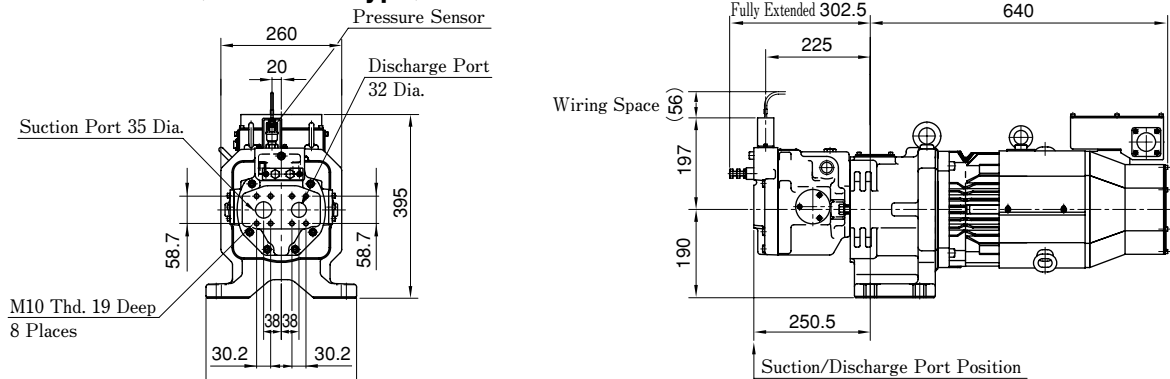

● For other dimensions, see the figure for the side port type.

**ASR5- \* J-HWS- (Side Port Type)**

**Dual Displacement Type**

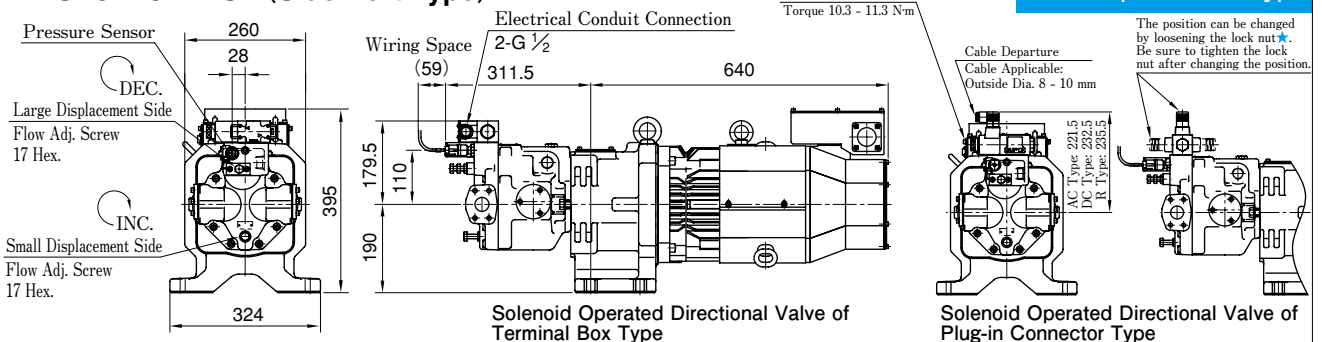

● For other dimensions, see the figure for the single displacement type.

**ASR5- \* J-HW- (Axial Port Type)**

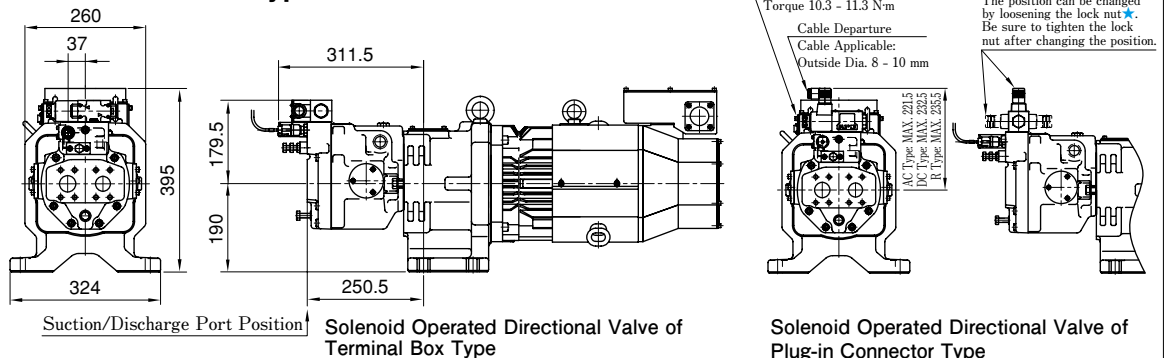

● For other dimensions, see the figures for the single displacement type and the dual displacement side port type.



# AMSR Controller

The AMSR controller is used to drive ASR series AC servo motor driven pumps. With an optimal design for the ASR pumps, the controller can maximize the pump performance. The AMSR controller is included with the ASR series pumps.



## Specifications

Model Numbers		AMSR- *C- *00-10	AMSR-2DE- *00-10	AMSR- *FGI- *00-10	AMSR- *HJL- *00-10	AMSR- *KMO- *00-10
Control Unit Specifications	Command Signal Input Voltage	0 - +10 V DC				
	Command Signal Input Impedance	10 kΩ				
	Monitor Output Voltage	0 - +10 V DC				
	Sequence Input Signal	Photocoupler Input 8ch				
	Sequence Output Signal	Open Collector Output 6ch				
Main Circuit Power	Voltage/Frequency	200 V	AC 200 to 230 V, 50/60 Hz, 3-Phase			
		400 V	AC 380 to 480, 50/60 Hz, 3-Phase			
	Permissible Voltage Fluctuation	200 V	AC 170 to 253 V, 3-Phase			
		400 V	AC 323 to 528 V, 3-Phase			
Permissible Frequency Fluctuation	Within ±5%					
Power Supply Capacity	6.8 kVA	8.6 kVA	12 kVA	16 kVA	22 kVA	
DB (Dynamic Brake)	Built-in			External Option		
Cooling System	Fan-cooling, Open (IP 00)					
Environmental Condition	Ambient Temperature	0 - +50 °C (No Freezing)				
	Ambient Humidity	90 %RH or less (No Condensation)				
Protective Functions	<ul style="list-style-type: none"> <li>· Overcurrent Shutdown</li> <li>· Servo Motor Overheat Protection</li> <li>· Undervoltage Protection</li> <li>· Excess Error Protection</li> <li>· Regenerative Overvoltage Shutdown</li> <li>· Encoder Malfunction Protection</li> <li>· Instantaneous Power Failure Protection</li> <li>· Overload Shutdown</li> <li>· Regeneration Malfunction Protection</li> <li>· Overspeed Protection</li> </ul>					
Mass kg	4.6	6.2	18		19	
Applicable Pump	ASR 1- *C ASR 2- *C	ASR 3-E	ASR 3- *G ASR 5- *G	ASR 5- *J ASR 10- *J	ASR 10- *M	

## Model Number Designation

AMSR	-2	C	-A	00	-10
Series Numbers	Power Supply Voltage	Amplifier Capacity kW	Function Selection	Parameter Number	Design Number
AMSR : AMSR Controller	2 : AC 200 V	DE : 7.0	A : Single B : Combination (Single Operation Allowed)	00 : Standard	10
	2 : AC 200 V	C : 5.0 FGI : 11.0 HJL : 15.0 KMO : 22.0			
	4 : AC 400 V				



**AMSR- \* C- \* 00-10**

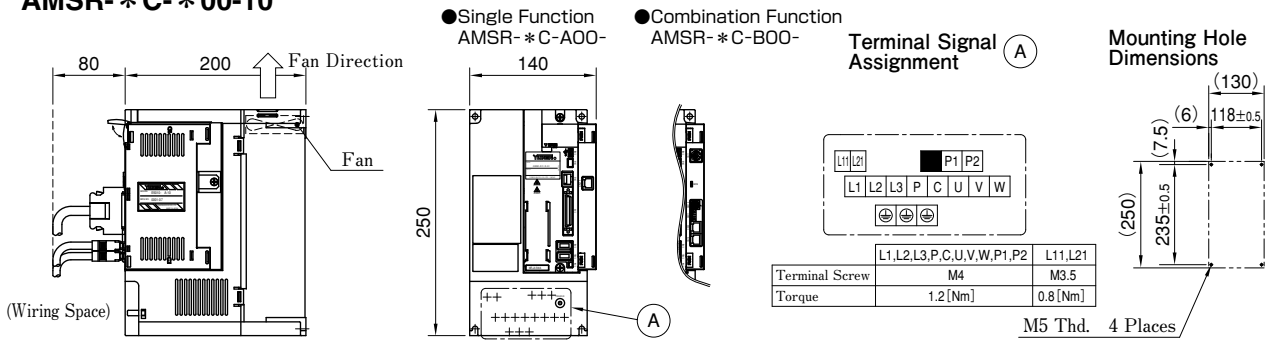

**AMSR-2DE- \* 00-10**

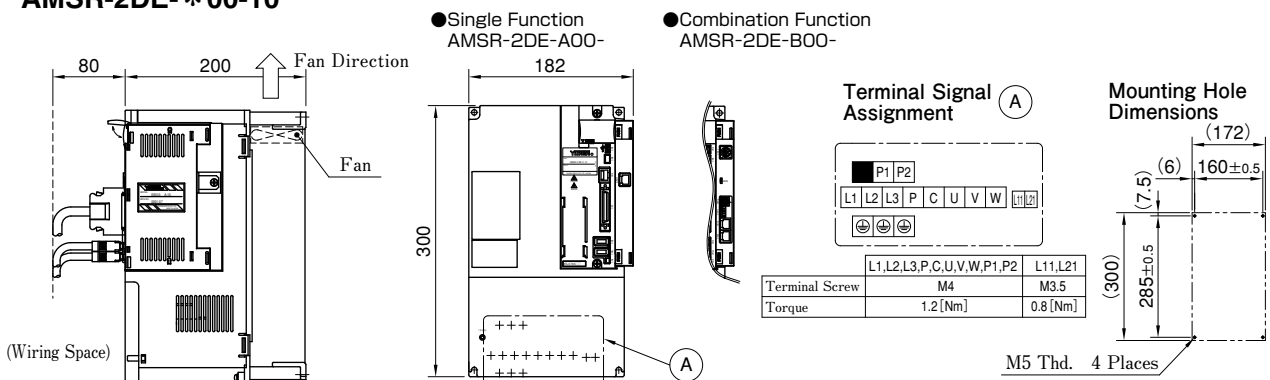

**AMSR- \* FGI/ \* HJL/ \* KMO- \* 00-10**

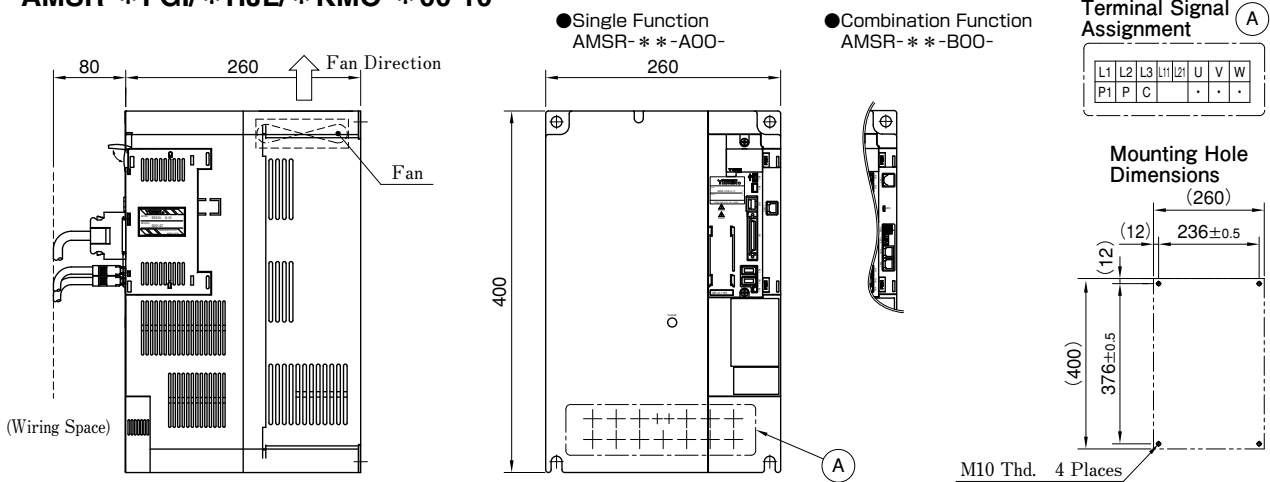

Terminal Symbol	L1~L3, U, V, W, P1, P, C	L11, L12
Terminal Screw Size/Torque	AMSR- * FGI/ * HJL- * 00-10	M6/3.0
	AMSR- * -KMO- * 00-10	M8/6.0
		M4/1.2

**Installation Standard**

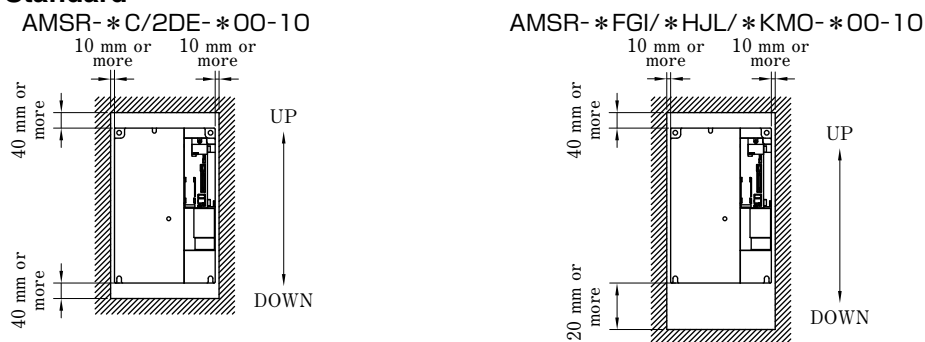

★ Consult us when installing multiple controllers next to each other.

**Terminal Names/Appearance**

● AMSR- \*C-A00-  
Single Function

● AMSR- \*C-B00-  
Combination Function

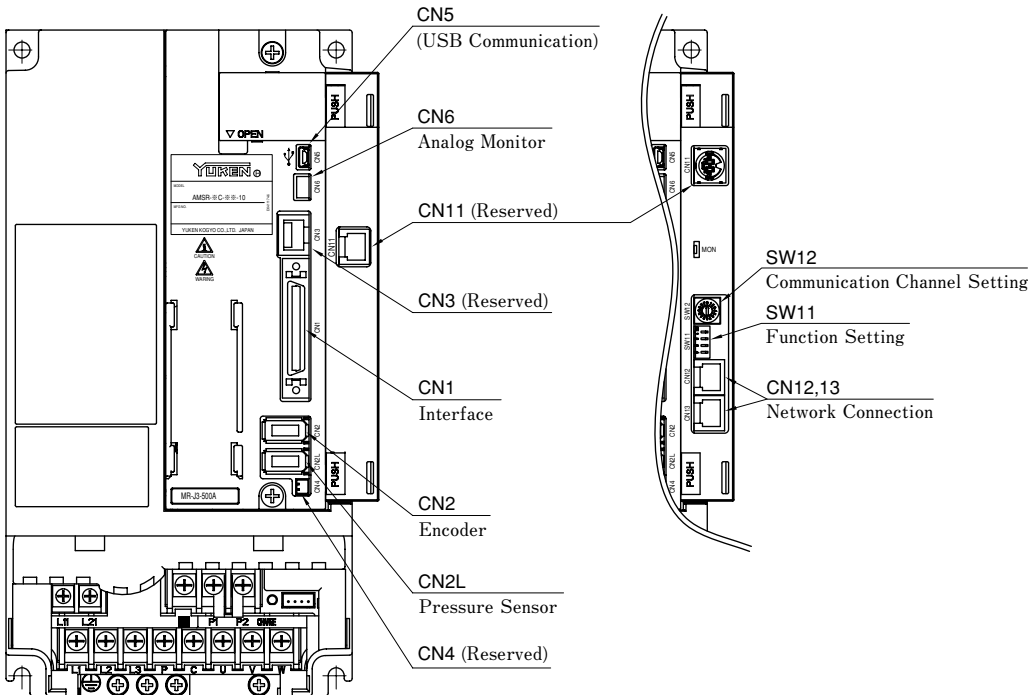

● AMSR-2DE-

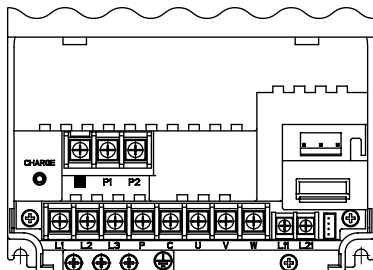

● AMSR- \*FGI/ \*HJL/ \*KMO-

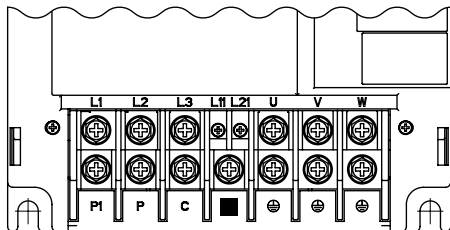

Function	Symbol	Terminal Name	Terminal Channel	Description
Single/ Combination	CN5	USB Communication	—	With the USB communication function, servo operation, parameter change, and monitor function can be performed on a PC. Recommended Cable USB Cable: Mini B Type
			1	For the manufacturer's setting. : Always OFF.
Combination	SW11	Function Selection	2	Reserved.
			3	For switching single and combination operations. OFF: Combination, ON: Single
			4	For network termination setting. OFF: None, ON: 150 Ω
			0	Master station
	SW12	Communication Channel Selection	1~F	Slave station
			CN12, CN13	Network Connection

**Terminal Block**

Connection (Use)	Signal Name	Description	
		AMSR-2C/2DE/ 2FGI/2HJL/2KMO	AMSR-4C/4FGI/ 4HJL/4KMO
DC Reactor for Power Factor Improvement	P1	P1 - P2 is short-circuited by default (the DC reactor cannot be used).★1	
	P2		
Regenerative Converter Brake Unit	N	Not connected.★1	

★1 Contact us when connecting the units.

For the details of CN1, CN2L, and CN6, consult us separately.

Wire Connection Diagram

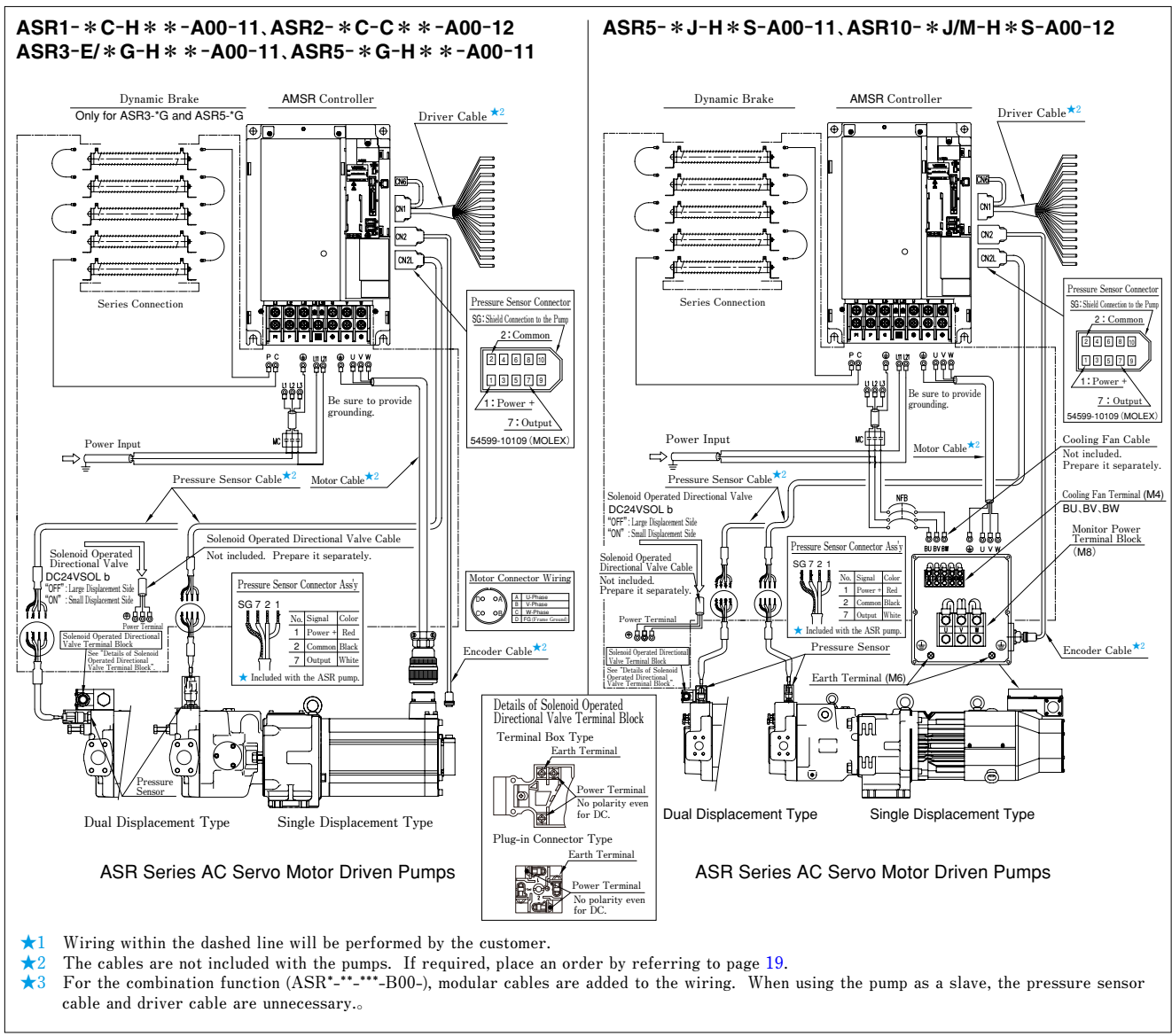

Connectors

	CN1	CN2L	CN6
Housing	10150-3000VE (3M)	54599-1019 (MOLEX)	51004-0300 (MOLEX)
Terminal	—		—
Case	10350-52F0-008 (3M)		50011-8100 (MOLEX)
Cable	Core Size	AWG #24 - #30	AWG #24 - #34
	Covered Dia.	φ 1.2 - φ 1.5	φ 1.6 MAX
	Strip Length	2.0 - 2.5mm	1.5 - 2.4mm

Motor Cable Plug/Cable Clamp

Model Numbers	Motor Cable Plug		Cable Clamp
	Straight	L-shaped	
ASR 1/ASR 2	MS3106B22 - 22S	MS3108B22 - 22S	MS3057 - 12A
ASR 3- * G	MS3106B32 - 17S	MS3108B32 - 17S	MS3057 - 20A

DDK Ltd.

Wiring Types

Terminals and Cables	Wiring mm <sup>2</sup>
L11 · L21	1.25 (AWG16) ★
Pressure Sensor Cable	0.5 (AWG20)

● Common Wiring      ● Dynamic Brake  
 Wiring : 5.5mm<sup>2</sup> (AWG10) ★

Power Classification

Electric Source	Model Numbers	Wiring mm <sup>2</sup>	
		Power Input L1, L2, L3 ★	Motor Cable U, V, W ★
AC 200 V 3-Phase	ASR1/ASR2/ASR3-C	5.5 (AWG10)	5.5 (AWG10)
	ASR3-E	8 (AWG8)	8 (AWG8)
	ASR3/ASR5-G	14 (AWG6)	22 (AWG4)
	ASR5/ASR10-J	22 (AWG4)	22 (AWG4)
	ASR10-M	50 (AWG1/0)	30 (AWG2)
AC 400 V 3-Phase	ASR1/ASR2/ASR3-4C	5.5 (AWG10)	5.5 (AWG10)
	ASR3/ASR5-4G	8 (AWG8)	8 (AWG8)
	ASR5/ASR10-4J	14 (AWG6)	8 (AWG8)
	ASR10-4M	14 (AWG6)	22 (AWG4)

★ Use a 600 V vinyl-insulated cable.

## Cable Numbers

The cables are not included with the ASR pumps. If required, place an order by referring to the list below. The cables other than the motor cable are common for all models.

### Motor Cable

ASR Pump Model Numbers	Cable Model Numbers	Remarks
ASR 1-*C-H*-*-00-11	YSDC-M1-29-☆-★-10	☆ : Plug Type S : Straight, L : L-shaped ★ : Cable Length 03 : 3 m 05 : 5 m 10 : 10 m 15 : 15 m 20 : 20 m 30 : 30 m N : Plug and cable clamp only
ASR 2-*C-C*-*-00-12		
ASR 3-E-H*-*-00-11	YSDC-M1-44S-☆-★-10	
ASR 3-G-H*-*-00-11	YSDC-M1-1A-☆-★-10	
ASR 3-4G-H*-*-00-11	YSDC-M1-44S-☆-★-10	
ASR 5-G-H*-*-00-11	YSDC-M1-1A-☆-★-10	
ASR 5-4G-H*-*-00-11	YSDC-M1-44S-☆-★-10	

### Driver Cable/Encoder Cable/Pressure Sensor Cable

Cable Type	Cable Model Numbers	Remarks
Driver Cable	YSDC-D14-00-★-10	★ : Cable Length 01 : 1 m 02 : 2 m 03 : 3 m 05 : 5 m 10 : 10 m 20 : 20 m
Encoder Cable	YSDC-E7-S-★-10	★ : Cable Length 02 : 2 m 05 : 5 m 10 : 10 m
Pressure Sensor Cable	Consult us separately.	

## Dynamic Brake

### Specifications

AMSR Controller Model Numbers	Dynamic Brake Model	Qty.	Permissible Regeneration W	Regeneration with Fan W	Resistance $\Omega$	Mass kg
AMSR-2FGI-	GRZG400-1.5 $\Omega$	4	500	800	6 (1.5 $\Omega$ ×4)	3.2 (0.8kg×4)
AMSR-2HJL-	GRZG400-0.9 $\Omega$	5	850	1300	4.5 (0.9 $\Omega$ ×5)	4.0 (0.8kg×5)
AMSR-2KMO-	GRZG400-0.6 $\Omega$				3 (0.6 $\Omega$ ×5)	
AMSR-4FGI-	GRZG400-5.0 $\Omega$	4	500	800	20 (5.0 $\Omega$ ×4)	3.2 (0.8kg×4)
AMSR-4HJL-	GRZG400-2.5 $\Omega$	5	850	1300	12.5 (2.5 $\Omega$ ×5)	4.0 (0.8kg×5)
AMSR-4KMO-	GRZG400-2.0 $\Omega$				10 (2.0 $\Omega$ ×5)	

★1. Dynamic brakes are included with the ASR pumps.

★2. Dynamic brakes may become excessively heated. Use heat-resistant and fireproof wires and avoid their contact with the brakes.

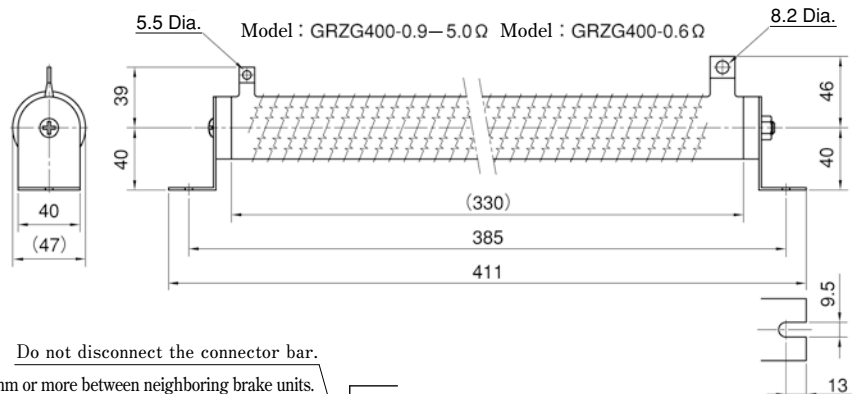

### Connection

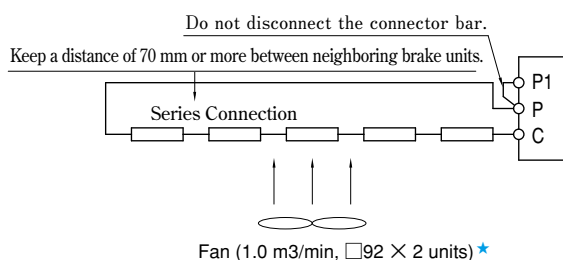

★Recommended fan capacity for fan cooling. In this case, change the setting of parameter No. PA02 from "0000" to "00FA".

# "F5" Series Pipe Flange Kits

## 4 Bolt Solid Flanges (SAE)

The dimensions of the flange mounting surface are based upon SAE 4 Bolt Split Flange (Standard Pressure Series).

### Model Number Designation

F5	-06	-A	-10
Series Number	Flange Size	Type of Pipe Connection	Design Standards
F5	Refer to below table	A : Threaded Connection B : Socket Welding C : Butt Welding	10

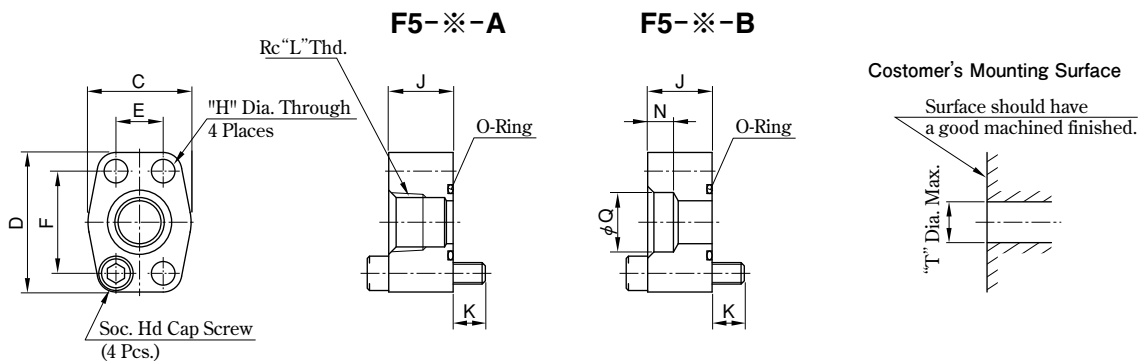

Kit Number	Piping Size	Dimension mm										O-Ring (JIS B 2401 Hs90)	Socket Head Cap Screw (4 Pcs.) (JIS B 1176)	Max. Operating Pressure MPa	Approx. Mass kg	Tightening Torque Nm		
		C	D	E	F	H	J	K	L	N	Q					T	Recommendation	Tolerance
F5-04W-A	3/8	40	54	17.5	38.1	8.8	30	10	3/8	-	-	13	P22	M 8 × 40	28	0.5	35	
F5-04W-B									-	9	17.8							
F5-04 -A	1/2	40	54	17.5	38.1	8.8	30	10	1/2	-	-	13	P22	M 8 × 40	28	0.5	35	
F5-04 -B									-	11	22.2							
F5-06X-A	3/4	48	65	22.2	47.6	8.8	30	15	3/4	-	-	19	G30	M 8 × 45	28	0.7	68.5	
F5-06X-B									-	12	27.7							
F5-06 -A	3/4	48	65	22.2	47.6	11	30	15	3/4	-	-	19	G30	M10 × 45	28	0.7	68.5	
F5-06 -B									-	12	27.7							
F5-08W-A	3/4	55	70	26.2	52.4	11	30	15	3/4	-	-	26	G35	M10 × 45	28	0.9	68.5	
F5-08W-B									-	12	27.7							
F5-08 -A	1	55	70	26.2	52.4	11	30	15	1	-	-	26	G35	M10 × 45	28	0.9	68.5	
F5-08 -B									-	14	34.5							
F5-10 -A	1 1/4	64	80	30.2	58.7	11	38	17	1 1/4	-	-	32	G40	M10 × 55	28	1.2	±10%	
F5-10 -B									-	16	43.2							
F5-12 -A	1 1/2	72	94	35.7	69.9	13.5	38	17	1 1/2	-	-	38	G50	M12 × 55	21	1.5	±10%	
F5-12 -B									-	18	49.1							
F5-16W-A	1 1/2	85	102	42.9	77.8	13.5	38	17	1 1/2	-	-	48	G60	M12 × 55	21	1.8	±10%	118
F5-16W-B									-	18	49.1							
F5-16 -A	2	85	102	42.9	77.8	13.5	38	17	2	-	-	51	G65	M12 × 55	17.5	1.7	±10%	118
F5-16 -B									-	20	61.1							
F5-20 -A	2 1/2	102	114	50.8	88.9	13.5	48	17	2 1/2	-	-	63	G75	M12 × 65	17.5	2.0	±10%	287
F5-20 -B									-	22	77.1							
F5-24 -A	3	116	135	61.9	106.4	17.5	53	17	3	-	-	76	G85	M16 × 70	3.5	2.7	±10%	287
F5-24 -B									-	25	90.0							
F5-28 -A	3 1/2	134	153	69.9	120.7	17.5	53	17	3 1/2	-	-	88	G100	M16 × 70	3.5	3.4	±10%	287
F5-28 -B									-	28	102.8							
F5-32 -A	4	150	162	77.8	130.2	17.5	53	17	4	-	-	101	G115	M16 × 70	3.5	3.7	±10%	287
F5-32 -B									-	28	115.5							

★1. Approx. mass is the value including socket head cap screw (4Pcs.).

★2. The values of tightening torque above apply to when these flanges are used for pressure line.

**F5-※-C**

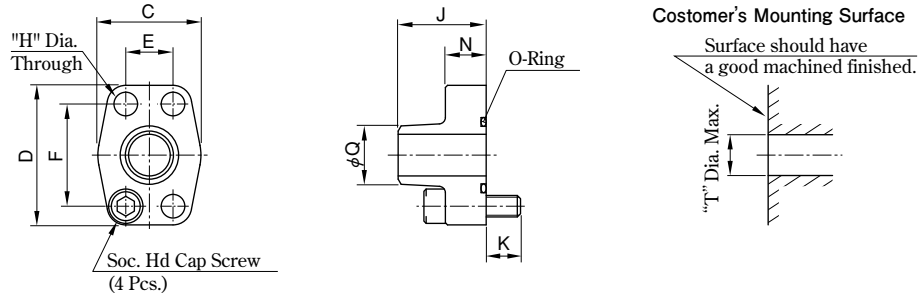

Kit Number	Piping Size	Dimension mm										O-Ring (JIS B 2401 Hs90)	Socket Head Cap Screw (4 Pcs.) (JIS B 1176)	Max. Operating Pressure MPa	Approx. Mass kg	Tightening Torque	
		C	D	E	F	H	J	K	N	Q	T					Recommendation	Tolerance
F5-04-C	1/2	40	54	17.5	38.1	8.8	39	13	17	21.7	13	P22	M 8 × 30	28	0.25	35	±10%
F5-06-C	3/4	48	65	22.2	47.6	11	41	16	19	27.2	19	G30	M10×35	28	0.35	68.5	
F5-08-C	1	55	70	26.2	52.4	11	42	16	19	34	26	G35	M10×35	28	0.45	68.5	
F5-10-C	1 1/4	64	80	30.2	58.7	11	44	16	19	42.7	32	G40	M10×35	28	0.63	68.5	
F5-12-C	1 1/2	72	94	35.7	69.9	13.5	50	18	22	48.6	38	G50	M12×40	21	1.3	118	
F5-16-C	2	85	102	42.9	77.8	13.5	50	18	22	60.5	51	G65	M12×40	17.5	1.3	118	
F5-20-C	2 1/2	102	114	50.8	88.9	13.5	50	20	25	76.3	63	G75	M12×45	14	1.4	118	

★1. Approx. mass is the value including socket head cap screw (4Pcs.).

★2. The values of tightening torque above apply to when these flanges are used for pressure line.

## Air Bleed Valves

These air bleed valves are designed to use, at the start-up of the pumps, to bleed off the air enclosed in the suction line or the other lines in the system.

### Specifications

Description	Model Numbers		
	ST1004-2-1002	ST1004-5-10	ST1004-10-10
Port Size	Rc 3/8 Thd.		
Max. Operating Pressure	25 MPa		
Reseating Pressure	0.15 MPa		
Cracking Pressure	0.34 MPa		
Flow Rate to Reseating	2 L/min	5 L/min	10 L/min
Range of Usage to Pump Output Flow	For Under 20 L/min	For 20 to 75 L/min	For Over 75 L/min



### Graphic Symbols

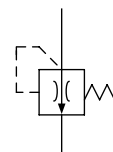

По вопросам продаж и поддержки обращайтесь:

Алматы (7273)495-231  
Ангарск (3955)60-70-56  
Архангельск (8182)63-90-72  
Астрахань (8512)99-46-04  
Барнаул (3852)73-04-60  
Белгород (4722)40-23-64  
Благовещенск (4162)22-76-07  
Брянск (4832)59-03-52  
Владивосток (423)249-28-31  
Владикавказ (8672)28-90-48  
Владимир (4922)49-43-18  
Волгоград (844)278-03-48  
Вологда (8172)26-41-59  
Воронеж (473)204-51-73  
Екатеринбург (343)384-55-89

Иваново (4932)77-34-06  
Ижевск (3412)26-03-58  
Иркутск (395)279-98-46  
Казань (843)206-01-48  
Калининград (4012)72-03-81  
Калуга (4842)92-23-67  
Кемерово (3842)65-04-62  
Киров (8332)68-02-04  
Коломна (4966)23-41-49  
Кострома (4942)77-07-48  
Краснодар (861)203-40-90  
Красноярск (391)204-63-61  
Курган (3522)50-90-47  
Курск (4712)77-13-04  
Липецк (4742)52-20-81

Магнитогорск (3519)55-03-13  
Москва (495)268-04-70  
Мурманск (8152)59-64-93  
Набережные Челны (8552)20-53-41  
Нижегород (831)429-08-12  
Новокузнецк (3843)20-46-81  
Новосибирск (383)227-86-73  
Ноябрьск (3496)41-32-12  
Омск (3812)21-46-40  
Орел (4862)44-53-42  
Оренбург (3532)37-68-04  
Пенза (8412)22-31-16  
Пермь (342)205-81-47  
Петрозаводск (8142)55-98-37  
Псков (8112)59-10-37

Ростов-на-Дону (863)308-18-15  
Рязань (4912)46-61-64  
Самара (846)206-03-16  
Санкт-Петербург (812)309-46-40  
Саранск (8342)22-96-24  
Саратов (845)249-38-78  
Севастополь (8692)22-31-93  
Симферополь (3652)67-13-56  
Смоленск (4812)29-41-54  
Сочи (862)225-72-31  
Ставрополь (8652)20-65-13  
Сургут (3462)77-98-35  
Сыктывкар (8212)25-95-17  
Тамбов (4752)50-40-97  
Тверь (4822)63-31-35

Тольятти (8482)63-91-07  
Томск (3822)98-41-53  
Тула (4872)33-79-87  
Тюмень (3452)66-21-18  
Улан-Удэ (3012)59-97-51  
Ульяновск (8422)24-23-59  
Уфа (347)229-48-12  
Хабаровск (4212)92-98-04  
Чебоксары (8352)28-53-07  
Челябинск (351)202-03-61  
Череповец (8202)49-02-64  
Чита (3022)38-34-83  
Якутск (4112)23-90-97  
Ярославль (4852)69-52-93

Россия +7(495)268-04-70

Казахстан +7(7172)727-132

Киргизия +996(312)96-26-47

[yne@nt-rt.ru](mailto:yne@nt-rt.ru) || <https://yuken.nt-rt.ru>